

05-Oras Vascau-Strazi Colesti

Obiect

M5 PRESEDINTE DE SEDINTA
LAZA MATIUTA LIVIU

SECRETAR GENERAL UAT VASCAU
POP RODICA



Contacte



SC TERM SRL

PRESEDINTE DE SEDINTA
LAZA MATIUTA LIVIU



CONTRASEMNEAZA
SECRETAR GENERAL UAT VASCAU
POP RODICA





Descriere

M5

SC TERM SRL

PRESEDINTE DE SEDINTA
LAZA MATIUTA LIVIU

CONTRASEMNEAZA
SECRETAR GENERAL UAT VASCAU
POP RODICA



Fișa de date privind produsul

- LED street light 50 W



| | |
|-------------------------|-----------------------|
| Nr.articol | LED STREET LIGHT 50 W |
| P | 50.0 W |
| Φ Lampă | 6866 lm |
| Φ Corp de iluminat | 7257 lm |
| η | 105.70 % |
| Eficiența luminoasă | 145.1 lm/W |
| CCT | 4000 K |
| CRI | 70 |

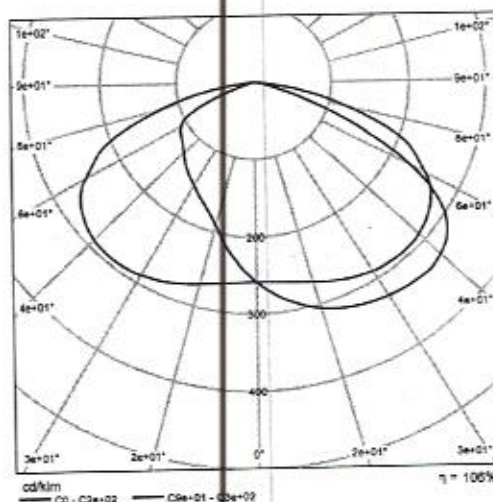

CDIL polar

PRESEDINTE DE SEDINTA
LAZA MATIUTA LIVIU

CONTRASEMNEAZA
SECRETAR GENERAL UAT VASCAU
POP RODICA



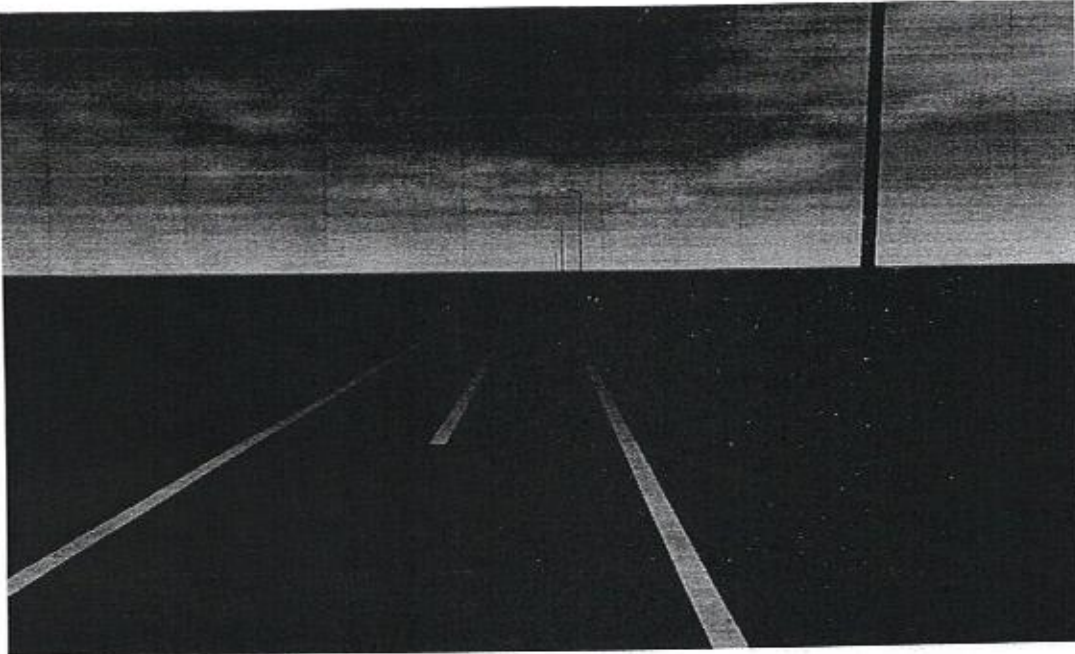

Stradă 1

Descriere

PRESEDINTE DE SEDINTA
LAZA MATIUTA LIVIU

CONTRASEMNEAZA
SECRETAR GENERAL UAT VASCAU
POP RODICA



Stradă 1

Rezumat (până la EN 13201:2015)

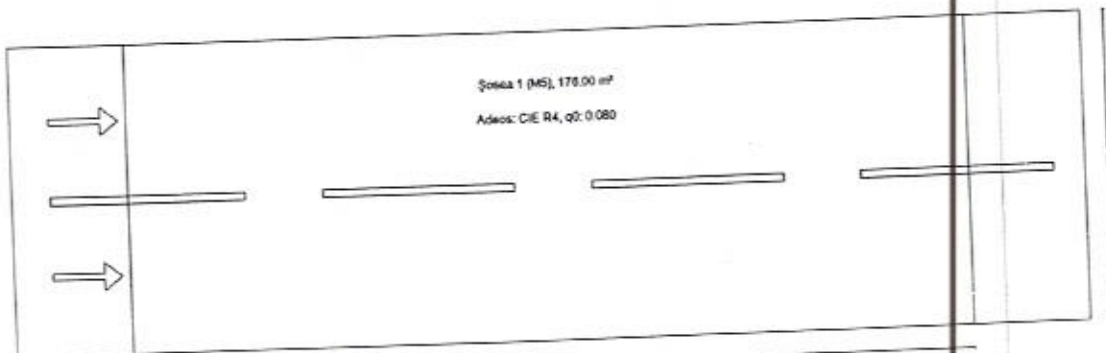

PRESEDINTE DE SEDINTA
LAZA MATIUTA LIVIU

CONTRASEMNEAZA
SECRETAR GENERAL UAT VASCAU
POP RODICA



Stradă 1

Rezumat (până la EN 13201:2015)

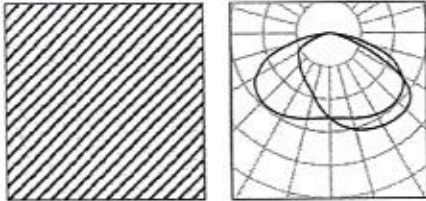

| | | | |
|--------------|-----------------------|-----------------------------|----------|
| Nr.articol | LED STREET LIGHT 50 W | P | 50.0 W |
| Nume articol | LED street light 50 W | $\Phi_{Lampă}$ | 6866 lm |
| Dotare | 1x 0 | $\Phi_{Corp\ de\ iluminat}$ | 7257 lm |
| | | η | 105.70 % |

LED street light 50 W (Pe o parte Jos)

| | |
|--|---|
| Distanță stâlp | 44.000 m |
| (1) Înălțimea punctului de lumină | 8.600 m |
| (2) Înălțimea în consolă a punctului de lumină | -1.000 m |
| (3) Înclinare consolă | 10.0° |
| (4) Lungime consolă | 1.500 m |
| Număr anual de ore de funcționare | 4000 h: 100.0 %, 50.0 W |
| Consum | 1150.0 W/km |
| ULR / ULOR | 0.00 / 0.00 |
| Intensități luminoase max. Orice direcție ce formează unghiul dat cu verticala în jos a corpurilor de iluminat instalate pentru utilizare. | $\geq 70^\circ$: 306 cd/klm $\geq 80^\circ$: 192 cd/klm $\geq 90^\circ$: 22.1 cd/klm |
| Clasă intensitate luminoasă Valorile intensității luminoase în [cd/klm] pentru calculul clasei intensității luminoase se referă la fluxul luminos al corpului de iluminat, conform EN 13201:2015. | G*1 |
| Clasă index ornamente | D.3 |

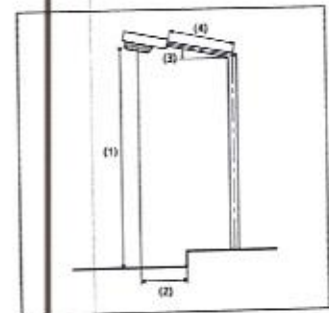

PRESEDINTE DE SEDINTA
LAZA MATIUTA LIVIU

CONTRASEMNEAZA
SECRETAR GENERAL UAT VASCAU
POP RODICA

Stradă 1

Rezumat (până la EN 13201:2015)

Rezultate pentru câmpurile de evaluare

| | Mărime | Calculat | Nominal | Conform |
|--------------|----------|------------------------|--------------------------|---------|
| Șosea 1 (M5) | L_m | 0.50 cd/m ² | ≥ 0.50 cd/m ² | ✓ |
| | U_o | 0.37 | ≥ 0.35 | ✓ |
| | U_l | 0.42 | ≥ 0.40 | ✓ |
| | TI | 8 % | ≤ 15 % | ✓ |
| | R_{Et} | 0.85 | ≥ 0.30 | ✓ |

Pentru instalare s-a luat în calcul un factor de întreținere de 0.91.

Rezultate pentru indicatorii de eficiență energetică

| | Mărime | Calculat | Consum |
|--|--------|----------------------------|--------------|
| Stradă 1 | D_p | 0.035 W/lx*m ² | - |
| LED street light 50 W (Pe o parte jos) | D_e | 1.1 kWh/m ² an, | 200.0 kWh/an |

PRESEDINTE DE SEDINTA
LAZA MATIUTA LIVIU



CONTRASEMNEAZA
SECRETAR GENERAL UAT VASCAU
POP RODICA



Stradă 1

Rezumat (până la EN 13201:2015)

Rezultate pentru câmpurile de evaluare

| | Mărime | Calculat | Nominal | Conform |
|--------------|--------|------------------------|--------------------------|---------|
| Șosea 1 (M5) | L_m | 0.50 cd/m ² | ≥ 0.50 cd/m ² | ✓ |
| | U_o | 0.37 | ≥ 0.35 | ✓ |
| | U_l | 0.42 | ≥ 0.40 | ✓ |
| | TI | 8 % | ≤ 15 % | ✓ |
| | R_E | 0.85 | ≥ 0.30 | ✓ |

Pentru instalare s-a luat în calcul un factor de întreținere de 0.91.

Rezultate pentru indicatorii de eficiență energetică

| | Mărime | Calculat | Consum |
|--|--------|----------------------------|--------------|
| Stradă 1 | D_p | 0.035 W/lx*m ² | - |
| LED street light 50 W (Pe o parte jos) | D_e | 1.1 kWh/m ² an, | 200.0 kWh/an |

PRESEDINTE DE SEDINTA
LAZA MATIUTA LIVIU



CONTRASEMNEAZA
SECRETAR GENERAL UAT VASCAU
POP RODICA



Stradă 1

Şosea 1 (M5)

Rezultate pentru câmpul de evaluare

| | Mărime | Calculat | Nominal | Conform |
|--------------|----------|------------------------|--------------------------|---------|
| Şosea 1 (M5) | L_m | 0.50 cd/m ² | ≥ 0.50 cd/m ² | ✓ |
| | U_o | 0.37 | ≥ 0.35 | ✓ |
| | U_l | 0.42 | ≥ 0.40 | ✓ |
| | TI | 8 % | ≤ 15 % | ✓ |
| | R_{E1} | 0.85 | ≥ 0.30 | ✓ |

Rezultate pentru observator

| | Mărime | Calculat | Nominal | Conform |
|---|--------|------------------------|--------------------------|---------|
| Observator 1 Poziție: -60.000 m, 1.000 m, 1.500 m | L_m | 0.50 cd/m ² | ≥ 0.50 cd/m ² | ✓ |
| | U_o | 0.38 | ≥ 0.35 | ✓ |
| | U_l | 0.45 | ≥ 0.40 | ✓ |
| | TI | 8 % | ≤ 15 % | ✓ |
| Observator 2 Poziție: -60.000 m, 3.000 m, 1.500 m | L_m | 0.55 cd/m ² | ≥ 0.50 cd/m ² | ✓ |
| | U_o | 0.37 | ≥ 0.35 | ✓ |
| | U_l | 0.42 | ≥ 0.40 | ✓ |
| | TI | 6 % | ≤ 15 % | ✓ |



Valoarea de întreținere, intensitatea de iluminare orizontală [lx] (Linii Isolux)

PRESEDINTE DE SEDINTA
LAZA MATIUTA LIVIU

CONTRASEMNEAZA
SECRETAR GENERAL UAT VASCAU
POP RODICA

Stradă 1

Șosea 1 (M5)

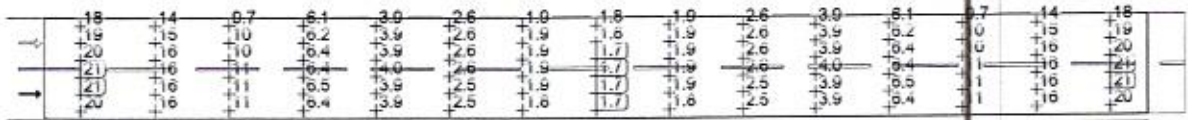

Valoarea de întreținere, intensitatea de iluminare orizontală [lx] (Raster valoric)

| | | | | | | | | | | | | | | | |
|-------|-------|-------|-------|--------|--------|--------|--------|--------|--------|--------|--------|--------|--------|--------|--------|
| m | 1.467 | 4.400 | 7.333 | 10.267 | 13.200 | 16.133 | 19.067 | 22.000 | 24.933 | 27.867 | 30.800 | 33.733 | 36.667 | 39.600 | 42.533 |
| 3.667 | 17.80 | 14.50 | 9.66 | 6.07 | 3.85 | 2.58 | 1.94 | 1.77 | 1.94 | 2.58 | 3.85 | 6.07 | 9.66 | 14.50 | 17.80 |
| 3.000 | 19.10 | 15.21 | 10.04 | 6.24 | 3.91 | 2.59 | 1.94 | 1.76 | 1.94 | 2.59 | 3.91 | 6.24 | 10.04 | 15.21 | 19.10 |
| 2.333 | 20.28 | 15.79 | 10.36 | 6.36 | 3.94 | 2.58 | 1.93 | 1.75 | 1.93 | 2.58 | 3.94 | 6.36 | 10.36 | 15.79 | 20.28 |
| 1.667 | 20.84 | 16.20 | 10.59 | 6.44 | 3.96 | 2.57 | 1.91 | 1.73 | 1.91 | 2.57 | 3.96 | 6.44 | 10.59 | 16.20 | 20.84 |
| 1.000 | 20.73 | 16.42 | 10.72 | 6.47 | 3.95 | 2.54 | 1.88 | 1.71 | 1.88 | 2.54 | 3.95 | 6.47 | 10.72 | 16.42 | 20.73 |
| 0.333 | 20.26 | 16.28 | 10.64 | 6.40 | 3.89 | 2.49 | 1.84 | 1.67 | 1.84 | 2.49 | 3.89 | 6.40 | 10.64 | 16.28 | 20.26 |

Valoarea de întreținere, intensitatea de iluminare orizontală [lx] (Tabel de valori)

| | E_m | E_{min} | E_{max} | g_1 | g_2 |
|---|---------|-----------|-----------|-------|-------|
| Valoarea de întreținere, intensitatea de iluminare orizontală | 8.20 lx | 1.67 lx | 20.8 lx | 0.203 | 0.080 |



Observator 1: Valoarea de întreținere, densitatea luminii cu carosabil uscat [cd/m²] (Linii Isolux)

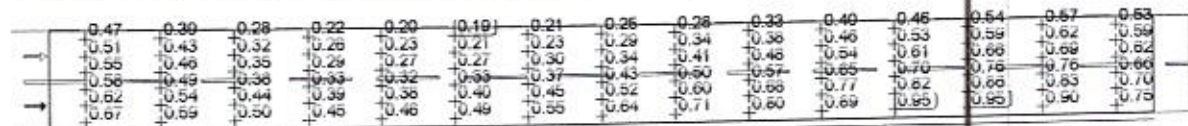

Observator 1: Valoarea de întreținere, densitatea luminii cu carosabil uscat [cd/m²] (Raster valoric)

| | | | | | | | | | | | | | | | |
|-------|-------|-------|-------|--------|--------|--------|--------|--------|--------|--------|--------|--------|--------|--------|--------|
| m | 1.467 | 4.400 | 7.333 | 10.267 | 13.200 | 16.133 | 19.067 | 22.000 | 24.933 | 27.867 | 30.800 | 33.733 | 36.667 | 39.600 | 42.533 |
| 3.667 | 0.47 | 0.39 | 0.28 | 0.22 | 0.20 | 0.19 | 0.21 | 0.25 | 0.28 | 0.33 | 0.40 | 0.46 | 0.54 | 0.57 | 0.53 |
| 3.000 | 0.51 | 0.43 | 0.32 | 0.26 | 0.23 | 0.21 | 0.23 | 0.29 | 0.34 | 0.38 | 0.46 | 0.54 | 0.61 | 0.62 | 0.59 |
| 2.333 | 0.55 | 0.46 | 0.35 | 0.29 | 0.27 | 0.27 | 0.30 | 0.34 | 0.41 | 0.48 | 0.57 | 0.65 | 0.70 | 0.76 | 0.69 |
| | 0.58 | 0.49 | 0.38 | 0.32 | 0.32 | 0.33 | 0.37 | 0.43 | 0.50 | 0.57 | 0.65 | 0.72 | 0.78 | 0.83 | 0.70 |
| | 0.62 | 0.54 | 0.44 | 0.39 | 0.38 | 0.40 | 0.45 | 0.52 | 0.60 | 0.68 | 0.77 | 0.82 | 0.88 | 0.93 | 0.79 |
| | 0.67 | 0.59 | 0.50 | 0.45 | 0.46 | 0.49 | 0.55 | 0.64 | 0.71 | 0.80 | 0.89 | 0.95 | 1.00 | 1.00 | 0.79 |

PRESEDINTE DE SEDINTA
LAZA MATIUTA LIVIU

CONTRASEMNEAZA
SECRETAR GENERAL UAT VASCAU
POP RODICA

Stradă 1

Șosea 1 (M5)

| | | | | | | | | | | | | | | | |
|-------|-------|-------|-------|--------|--------|--------|--------|--------|--------|--------|--------|--------|--------|--------|--------|
| m | 1.467 | 4.400 | 7.333 | 10.267 | 13.200 | 16.133 | 19.067 | 22.000 | 24.933 | 27.867 | 30.800 | 33.733 | 36.667 | 39.600 | 42.533 |
| 1.667 | 0.58 | 0.49 | 0.38 | 0.33 | 0.32 | 0.33 | 0.37 | 0.43 | 0.50 | 0.57 | 0.65 | 0.70 | 0.76 | 0.76 | 0.66 |
| 1.000 | 0.62 | 0.54 | 0.44 | 0.39 | 0.38 | 0.40 | 0.45 | 0.52 | 0.60 | 0.68 | 0.77 | 0.82 | 0.86 | 0.83 | 0.70 |
| 0.333 | 0.67 | 0.59 | 0.50 | 0.45 | 0.46 | 0.49 | 0.55 | 0.64 | 0.71 | 0.80 | 0.89 | 0.95 | 0.95 | 0.90 | 0.75 |

Observator 1: Valoarea de întreținere, densitatea luminii cu carosabil uscat [cd/m²] (Tabel de valori)

| | L _m | L _{min} | L _{max} | g ₁ | g ₂ |
|--|------------------------|------------------------|------------------------|----------------|----------------|
| Observator 1: Valoarea de întreținere, densitatea luminii cu carosabil uscat | 0.50 cd/m ² | 0.19 cd/m ² | 0.95 cd/m ² | 0.377 | 0.200 |



Observator 1: Densitatea luminii la instalația nouă [cd/m²] (Linii Isolux)

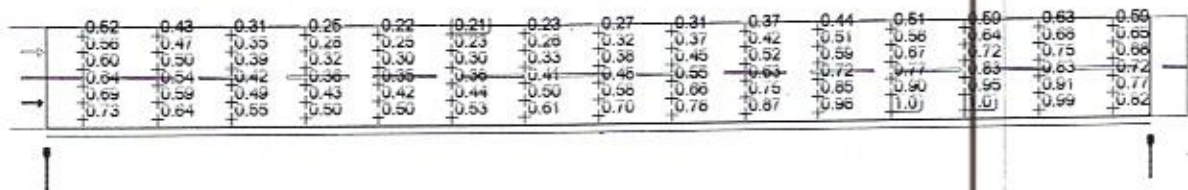

Observator 1: Densitatea luminii la instalația nouă [cd/m²] (Raster valoric)

| | | | | | | | | | | | | | | | |
|-------|-------|-------|-------|--------|--------|--------|--------|--------|--------|--------|--------|--------|--------|--------|--------|
| m | 1.467 | 4.400 | 7.333 | 10.267 | 13.200 | 16.133 | 19.067 | 22.000 | 24.933 | 27.867 | 30.800 | 33.733 | 36.667 | 39.600 | 42.533 |
| 3.667 | 0.52 | 0.43 | 0.31 | 0.25 | 0.22 | 0.21 | 0.23 | 0.27 | 0.31 | 0.37 | 0.44 | 0.51 | 0.59 | 0.63 | 0.59 |
| 3.000 | 0.56 | 0.47 | 0.35 | 0.28 | 0.25 | 0.23 | 0.26 | 0.32 | 0.37 | 0.42 | 0.51 | 0.58 | 0.64 | 0.68 | 0.65 |
| 2.333 | 0.60 | 0.50 | 0.39 | 0.32 | 0.30 | 0.30 | 0.33 | 0.38 | 0.45 | 0.52 | 0.59 | 0.67 | 0.72 | 0.75 | 0.68 |
| 1.667 | 0.64 | 0.54 | 0.42 | 0.36 | 0.35 | 0.36 | 0.41 | 0.48 | 0.55 | 0.63 | 0.72 | 0.77 | 0.83 | 0.83 | 0.72 |
| 1.000 | 0.69 | 0.59 | 0.49 | 0.43 | 0.42 | 0.44 | 0.50 | 0.58 | 0.66 | 0.75 | 0.85 | 0.90 | 0.95 | 0.91 | 0.77 |
| 0.333 | 0.73 | 0.64 | 0.55 | 0.50 | 0.50 | 0.53 | 0.61 | 0.70 | 0.78 | 0.87 | 0.98 | 1.04 | 1.05 | 0.99 | 0.82 |

Observator 1: Densitatea luminii la instalația nouă [cd/m²] (Tabel de valori)

| | L _m | L _{min} | L _{max} | g ₁ | g ₂ |
|---|------------------------|------------------------|------------------------|----------------|----------------|
| Observator 1: Densitatea luminii la instalația nouă | 0.55 cd/m ² | 0.21 cd/m ² | 1.05 cd/m ² | 0.377 | 0.200 |

PRESEDINTE DE SEDINTA
LAZA MATIUTA LIVIU

CONTRASEMNEAZA
SECRETAR GENERAL UAT VASCAU
POP RODICA

Stradă 1
Șosea 1 (M5)

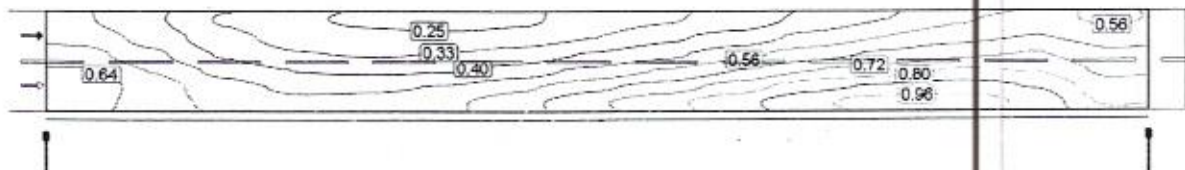

Observator 2: Valoarea de întreținere, densitatea luminii cu carosabil uscat [cd/m²] (Linii Isolux)

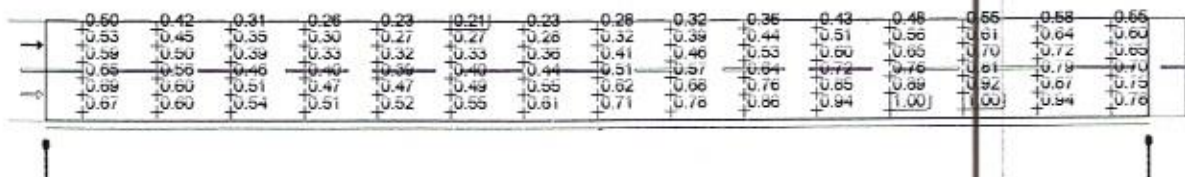

Observator 2: Valoarea de întreținere, densitatea luminii cu carosabil uscat [cd/m²] (Raster valoric)

| | | | | | | | | | | | | | | | |
|-------|-------|-------|-------|--------|--------|--------|--------|--------|--------|--------|--------|--------|--------|--------|--------|
| m | 1.467 | 4.400 | 7.333 | 10.267 | 13.200 | 16.133 | 19.067 | 22.000 | 24.933 | 27.867 | 30.800 | 33.733 | 36.667 | 39.600 | 42.533 |
| 3.667 | 0.50 | 0.42 | 0.31 | 0.26 | 0.23 | 0.21 | 0.23 | 0.28 | 0.32 | 0.36 | 0.43 | 0.48 | 0.55 | 0.58 | 0.55 |
| 3.000 | 0.53 | 0.45 | 0.35 | 0.30 | 0.27 | 0.27 | 0.28 | 0.32 | 0.39 | 0.44 | 0.51 | 0.56 | 0.61 | 0.64 | 0.60 |
| 2.333 | 0.59 | 0.50 | 0.39 | 0.33 | 0.32 | 0.33 | 0.36 | 0.41 | 0.46 | 0.53 | 0.60 | 0.65 | 0.70 | 0.72 | 0.65 |
| 1.667 | 0.69 | 0.56 | 0.46 | 0.40 | 0.39 | 0.40 | 0.44 | 0.51 | 0.57 | 0.64 | 0.72 | 0.76 | 0.81 | 0.79 | 0.70 |
| 1.000 | 0.67 | 0.60 | 0.51 | 0.47 | 0.47 | 0.49 | 0.55 | 0.62 | 0.68 | 0.76 | 0.85 | 0.89 | 0.92 | 0.87 | 0.75 |
| 0.333 | 0.67 | 0.60 | 0.54 | 0.51 | 0.52 | 0.55 | 0.61 | 0.71 | 0.78 | 0.86 | 0.94 | 1.00 | 1.00 | 0.94 | 0.78 |

Observator 2: Valoarea de întreținere, densitatea luminii cu carosabil uscat [cd/m²] (Tabel de valori)

| | L _m | L _{min} | L _{max} | g ₁ | g ₂ |
|--|------------------------|------------------------|------------------------|----------------|----------------|
| Observator 2: Valoarea de întreținere, densitatea luminii cu carosabil uscat | 0.55 cd/m ² | 0.21 cd/m ² | 1.00 cd/m ² | 0.373 | 0.206 |

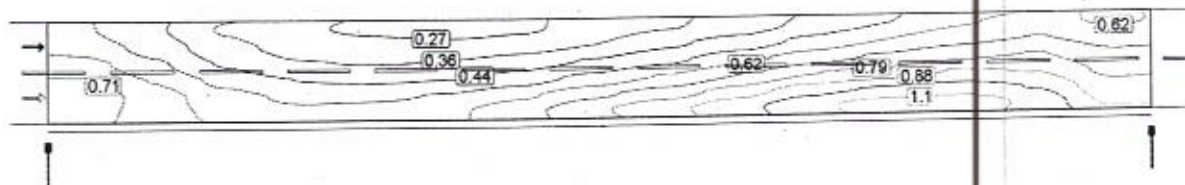

Observator 2: Densitatea luminii la instalația nouă [cd/m²] (Linii Isolux)

PRESEDINTE DE SEDINTA
LAZA MATIUTA LIVIU

CONTRASEMNEAZA
SECRETAR GENERAL UAT VASCAU
POP RODICA

Stradă 1

Șosea 1 (M5)

| | | | | | | | | | | | | | | | |
|---|------|------|------|------|------|------|------|------|------|------|------|------|------|------|------|
| → | 0.54 | 0.46 | 0.34 | 0.28 | 0.25 | 0.23 | 0.25 | 0.31 | 0.35 | 0.39 | 0.47 | 0.53 | 0.61 | 0.64 | 0.60 |
| | 0.59 | 0.50 | 0.38 | 0.32 | 0.30 | 0.29 | 0.31 | 0.36 | 0.43 | 0.48 | 0.56 | 0.62 | 0.67 | 0.71 | 0.66 |
| | 0.65 | 0.55 | 0.43 | 0.36 | 0.35 | 0.36 | 0.40 | 0.45 | 0.51 | 0.59 | 0.66 | 0.72 | 0.77 | 0.79 | 0.72 |
| | 0.71 | 0.61 | 0.50 | 0.44 | 0.43 | 0.44 | 0.49 | 0.56 | 0.62 | 0.71 | 0.79 | 0.83 | 0.89 | 0.87 | 0.77 |
| | 0.76 | 0.66 | 0.56 | 0.51 | 0.52 | 0.54 | 0.60 | 0.68 | 0.75 | 0.84 | 0.93 | 0.98 | 1.01 | 0.96 | 0.82 |
| | 0.74 | 0.66 | 0.59 | 0.56 | 0.57 | 0.60 | 0.68 | 0.76 | 0.86 | 0.94 | 1.04 | 1.10 | 1.10 | 1.03 | 0.86 |

Observator 2: Densitatea luminii la instalația nouă [cd/m²] (Raster valoric)

| | | | | | | | | | | | | | | | |
|-------|-------|-------|-------|--------|--------|--------|--------|--------|--------|--------|--------|--------|--------|--------|--------|
| m | 1.467 | 4.400 | 7.333 | 10.267 | 13.200 | 16.133 | 19.067 | 22.000 | 24.933 | 27.867 | 30.800 | 33.733 | 36.667 | 39.600 | 42.533 |
| 3.667 | 0.54 | 0.46 | 0.34 | 0.28 | 0.25 | 0.23 | 0.25 | 0.31 | 0.35 | 0.39 | 0.47 | 0.53 | 0.61 | 0.64 | 0.60 |
| 3.000 | 0.59 | 0.50 | 0.38 | 0.32 | 0.30 | 0.29 | 0.31 | 0.36 | 0.43 | 0.48 | 0.56 | 0.62 | 0.67 | 0.71 | 0.66 |
| 2.333 | 0.65 | 0.55 | 0.43 | 0.36 | 0.35 | 0.36 | 0.40 | 0.45 | 0.51 | 0.59 | 0.66 | 0.72 | 0.77 | 0.79 | 0.72 |
| 1.667 | 0.71 | 0.61 | 0.50 | 0.44 | 0.43 | 0.44 | 0.49 | 0.56 | 0.62 | 0.71 | 0.79 | 0.83 | 0.89 | 0.87 | 0.77 |
| 1.000 | 0.76 | 0.66 | 0.56 | 0.51 | 0.52 | 0.54 | 0.60 | 0.68 | 0.75 | 0.84 | 0.93 | 0.98 | 1.01 | 0.96 | 0.82 |
| 0.333 | 0.74 | 0.66 | 0.59 | 0.56 | 0.57 | 0.60 | 0.68 | 0.78 | 0.86 | 0.94 | 1.04 | 1.10 | 1.10 | 1.03 | 0.86 |

Observator 2: Densitatea luminii la instalația nouă [cd/m²] (Tabel de valori)

| | L _m | L _{min} | L _{max} | g ₁ | g ₂ |
|---|------------------------|------------------------|------------------------|----------------|----------------|
| Observator 2: Densitatea luminii la instalația nouă | 0.61 cd/m ² | 0.23 cd/m ² | 1.10 cd/m ² | 0.373 | 0.206 |

PRESEDINTE DE SEDINTA
LAZA MATIUTA LIVIU



CONTRASEMNEAZA
SECRETAR GENERAL UAT VASCAU
POP RODICA

