



04-Oras Vascau-Strazi Camp

Obiect

M5 PRESEDINTE DE SEDINTA
LAZA MATIUTA LIVIU



CONTRASEMNEAZA
SECRETAR GENERAL UAT VASCAU
POP RODICA

Contacte



SC TERM SRL

PRESEDINTE DE SEDINTA
LAZA MATIUTA LIVIU



CONTRASEMNEAZA
SECRETAR GENERAL UAT VASCAU
POP RODICA



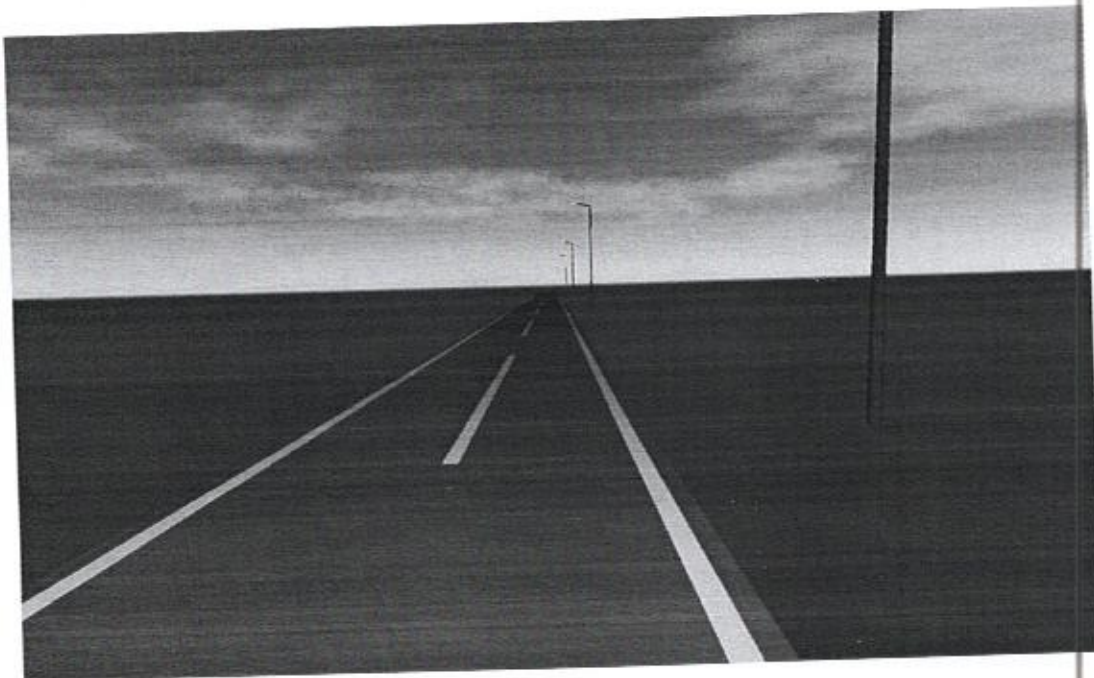

Descriere

M5

SC TERM SRL

PRESEDINTE DE SEDINTA
LAZA MATIUTA LIVIU

CONTRASEMNEAZA
SECRETAR GENERAL UAT VASCAU
POP RODICA



Fișa de date privind produsul

- LED street light 50 W



Nr.articol	LED STREET LIGHT 50 W
P	50.0 W
Φ Lampă	6866 lm
Φ Corp de iluminat	7257 lm
η	105.70 %
Eficiența luminoasă	145.1 lm/W
CCT	4000 K
CRI	70

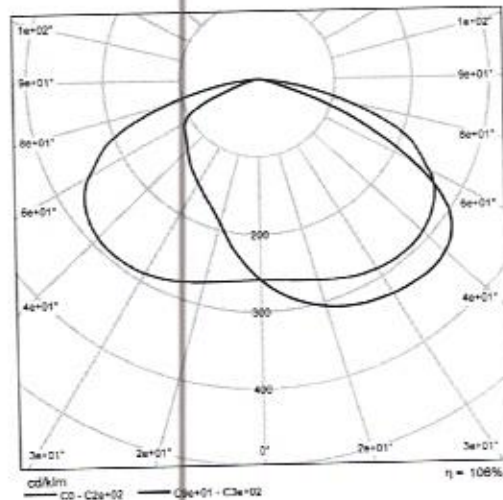

CDIL polar

PRESEDINTE DE SEDINTA
LAZA MATIUTA LIVIU

CONTRASEMNEAZA
SECRETAR GENERAL UAT VASCAU
POP RODICA

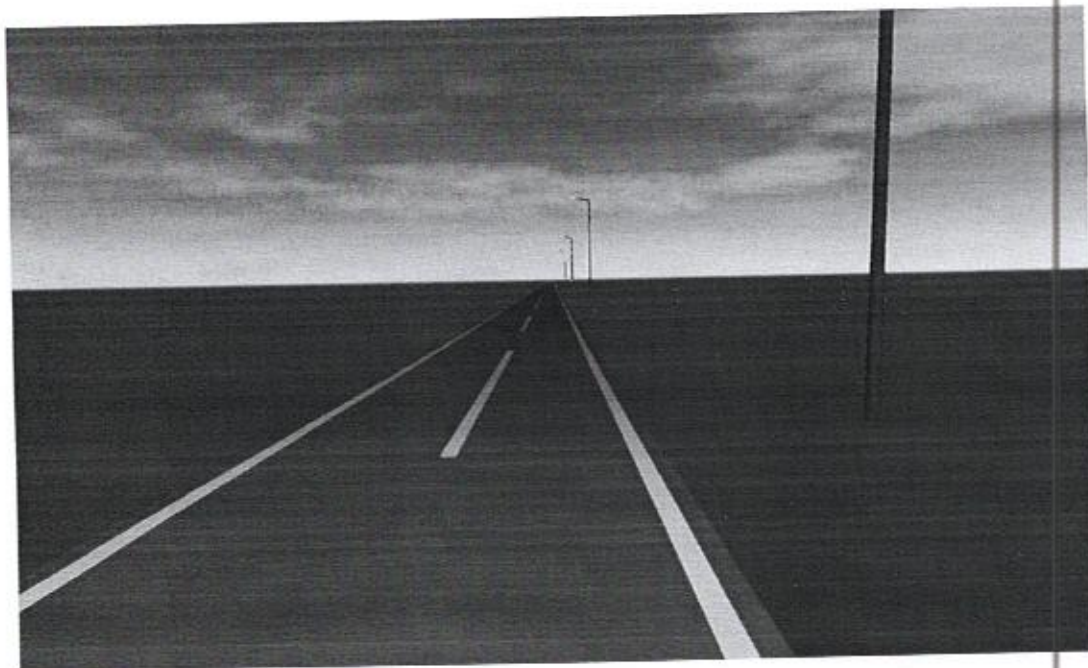

Stradă 1

Descriere

PRESEDINTE DE SEDINTA
LAZA MATIUTA LIVIU

CONTRASEMNEAZA
SECRETAR GENERAL UAT VASCAU
POP RODICA



Stradă 1

Rezumat (până la EN 13201:2015)

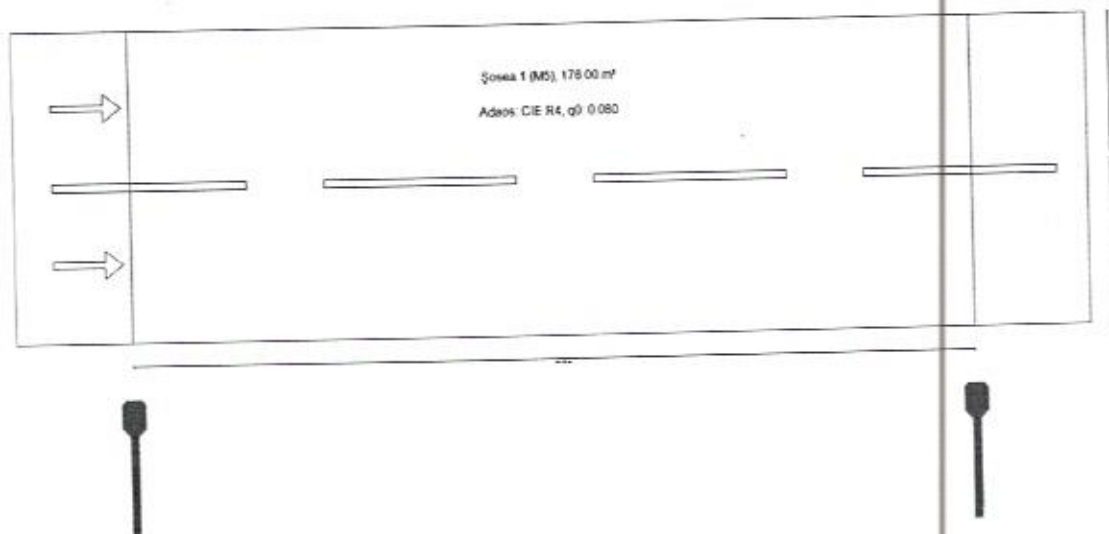

PRESEDINTE DE SEDINTA
LAZA MATIUTA LIVIU

CONTRASEMNEAZA
SECRETAR GENERAL UAT VASCAU
POP RODICA



Stradă 1

Rezumat (până la EN 13201:2015)

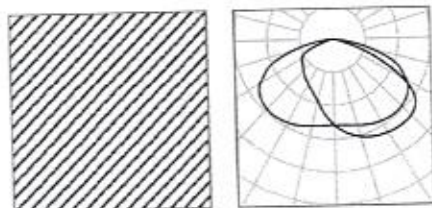

Nr.articol	LED STREET LIGHT 50 W	P	50.0 W
Nume articol	LED street light 50 W	$\Phi_{Lampă}$	6866 lm
Dotare	1x 0	$\Phi_{Corp\ de\ iluminat}$	7257 lm
		η	105.70 %

LED street light 50 W (Pe o parte Jos)

Distanță stâlp	44.000 m
(1) Înălțimea punctului de lumină	8.600 m
(2) Înșirarea în consolă a punctului de lumină	-1.000 m
(3) Înclinare consolă	10.0°
(4) Lungime consolă	1.500 m
Număr anual de ore de funcționare	4000 h: 100.0 %, 50.0 W
Consum	1150.0 W/km
ULR / ULOR	0.00 / 0.00
Intensități luminoase max. Orice direcție ce formează unghiul dat cu verticala în jos a corpurilor de iluminat instalate pentru utilizare.	$\geq 70^\circ$: 306 cd/klm $\geq 80^\circ$: 192 cd/klm $\geq 90^\circ$: 22.1 cd/klm
Clasă intensitate luminoasă Valorile intensității luminoase în (cd/klm) pentru calculul clasei intensității luminoase se referă la fluxul luminos al corpului de iluminat, conform EN 13201:2015.	G ⁺ 1
Clasă index ornamente	D.3

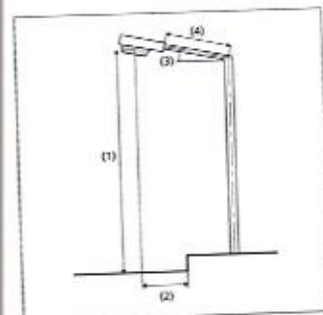

PRESEDINTE DE SEDINTA
LAZA MATIUTA LIVIU

CONTRASEMNEAZA
SECRETAR GENERAL UAT VASCAU
POP RODICA

Stradă 1

Rezumat (până la EN 13201:2015)

Rezultate pentru câmpurile de evaluare

	Mărire	Calculat	Nominal	Conform
Șosea 1 (M5)	L_m	0.50 cd/m ²	≥ 0.50 cd/m ²	✓
	U_o	0.37	≥ 0.35	✓
	U_l	0.42	≥ 0.40	✓
	TI	8 %	≤ 15 %	✓
	R_{L1}	0.85	≥ 0.30	✓

Pentru instalare s-a luat în calcul un factor de întreținere de 0.91.

Rezultate pentru indicatorii de eficiență energetică

	Mărire	Calculat	Consum
Stradă 1	D_p	0.035 W/lx·m ²	-
LED street light 50 W (Pe o parte Jos)	D_e	1.1 kWh/m ² an,	200.0 kWh/an

PRESEDINTE DE SEDINTA
LAZA MATIUTA LIVIU

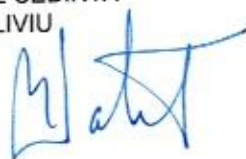

CONTRASEMNEAZA
SECRETAR GENERAL UAT VASCAU
POP RODICA



Stradă 1

Șosea 1 (M5)

Rezultate pentru câmpul de evaluare

	Mărime	Calculat	Nominal	Conform
Șosea 1 (M5)	L_m	0.50 cd/m ²	≥ 0.50 cd/m ²	✓
	U_o	0.37	≥ 0.35	✓
	U_i	0.42	≥ 0.40	✓
	TI	8 %	≤ 15 %	✓
	R_{Li}	0.85	≥ 0.30	✓

Rezultate pentru observator

	Mărime	Calculat	Nominal	Conform
Observator 1 Poziție: -60.000 m, 1.000 m, 1.500 m	L_m	0.50 cd/m ²	≥ 0.50 cd/m ²	✓
	U_o	0.38	≥ 0.35	✓
	U_i	0.45	≥ 0.40	✓
	TI	8 %	≤ 15 %	✓
	Observator 2 Poziție: -60.000 m, 3.000 m, 1.500 m	L_m	0.55 cd/m ²	≥ 0.50 cd/m ²
U_o		0.37	≥ 0.35	✓
U_i		0.42	≥ 0.40	✓
TI		6 %	≤ 15 %	✓

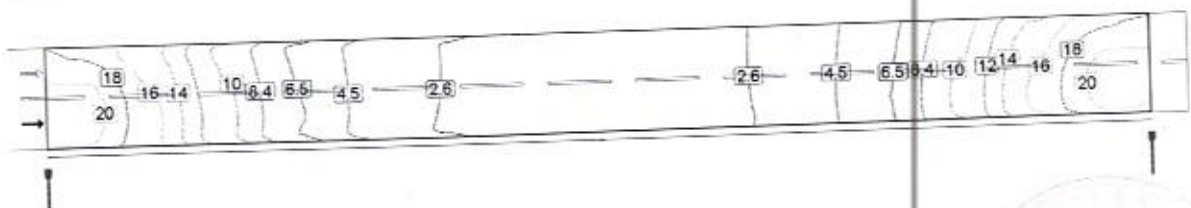

Valoarea de întreținere, intensitatea de iluminare orizontală [lx] (Linii Isolux)

PRESEDINTE DE SEDINTA
LAZA MATIUTA LIVIU

CONTRASEMNEAZA
SECRETAR GENERAL UAT VASCAU
POP RODICA



Stradă 1

Șosea 1 (M5)

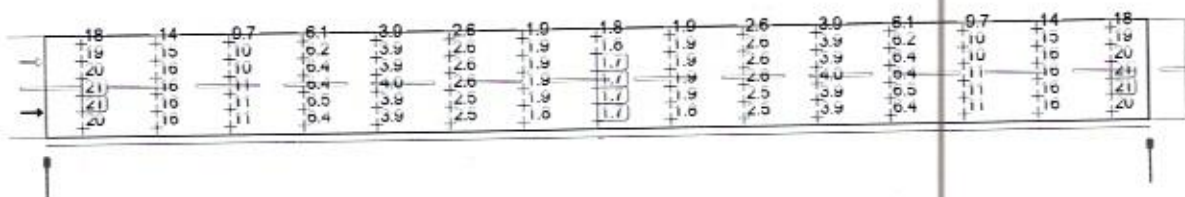

Valoarea de întreținere, intensitatea de iluminare orizontală [lx] (Raster valoric)

m	1.467	4.400	7.333	10.267	13.200	16.133	19.067	22.000	24.933	27.867	30.800	33.733	36.667	39.600	42.533
3.667	17.80	14.50	9.66	6.07	3.85	2.58	1.94	1.77	1.94	2.58	3.85	6.07	9.66	14.50	17.80
3.000	19.10	15.21	10.04	6.24	3.91	2.59	1.94	1.76	1.94	2.59	3.91	6.24	10.04	15.21	19.10
2.333	20.28	15.79	10.36	6.36	3.94	2.58	1.93	1.75	1.93	2.58	3.94	6.36	10.36	15.79	20.28
1.667	20.84	16.20	10.59	6.44	3.96	2.57	1.91	1.73	1.91	2.57	3.96	6.44	10.59	16.20	20.84
1.000	20.73	16.42	10.72	6.47	3.95	2.54	1.88	1.71	1.88	2.54	3.95	6.47	10.72	16.42	20.73
0.333	20.26	16.28	10.64	6.40	3.89	2.49	1.84	1.67	1.84	2.49	3.89	6.40	10.64	16.28	20.26

Valoarea de întreținere, intensitatea de iluminare orizontală [lx] (Tabel de valori)

	E_m	E_{min}	E_{max}	g_1	g_2
Valoarea de întreținere, intensitatea de iluminare orizontală	8.20 lx	1.67 lx	20.8 lx	0.203	0.080

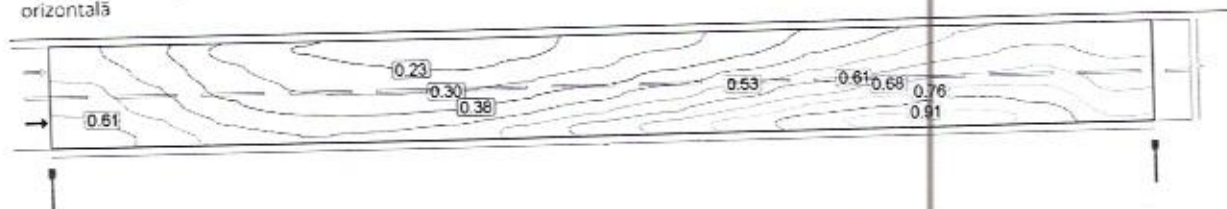

Observator 1: Valoarea de întreținere, densitatea luminii cu carosabil uscat [cd/m^2] (Linii Isolux)

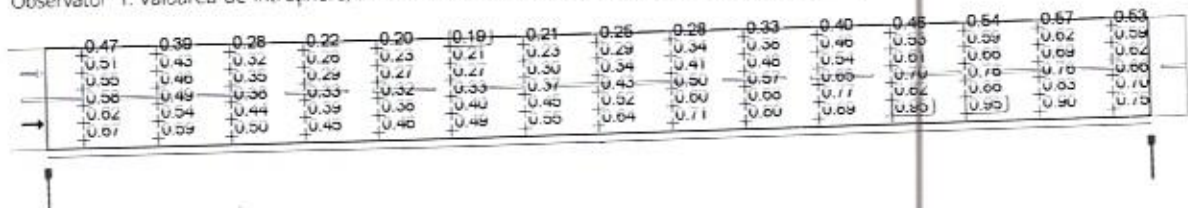

Observator 1: Valoarea de întreținere, densitatea luminii cu carosabil uscat [cd/m^2] (Raster valoric)

m	1.467	4.400	7.333	10.267	13.200	16.133	19.067	22.000	24.933	27.867	30.800	33.733	36.667	39.600	42.533
3.667	0.47	0.39	0.28	0.22	0.20	0.19	0.21	0.25	0.28	0.33	0.40	0.46	0.54	0.57	0.53
3.000	0.51	0.43	0.32	0.26	0.23	0.21	0.23	0.29	0.34	0.38	0.46	0.53	0.59	0.62	0.59
2.333	0.55	0.46	0.35	0.29	0.27	0.27	0.30	0.34	0.41	0.48	0.54	0.61	0.66	0.69	0.62

PRESEDINTE DE SEDINTA
LAZA MATIUTA LIVIU

CONTRASEMNEAZA
SECRETAR GENERAL UAT VASCAU
POP RODICA



Stradă 1

Șosea 1 (M5)

m	1.467	4.400	7.333	10.267	13.200	16.133	19.067	22.000	24.933	27.867	30.800	33.733	36.667	39.600	42.533
1.667	0.58	0.49	0.38	0.33	0.32	0.33	0.37	0.43	0.50	0.57	0.65	0.70	0.76	0.76	0.66
1.000	0.62	0.54	0.44	0.39	0.38	0.40	0.45	0.52	0.60	0.68	0.77	0.82	0.86	0.83	0.70
0.333	0.67	0.59	0.50	0.45	0.46	0.49	0.55	0.64	0.71	0.80	0.89	0.95	0.95	0.90	0.75

Observator 1: Valoarea de întreținere, densitatea luminii cu carosabil uscat [cd/m²] (Tabel de valori)

	L _m	L _{min}	L _{max}	g ₁	g ₂
Observator 1: Valoarea de întreținere, densitatea luminii cu carosabil uscat	0.50 cd/m ²	0.19 cd/m ²	0.95 cd/m ²	0.377	0.200



Observator 1: Densitatea luminii la instalația nouă [cd/m²] (Linii Isolux)

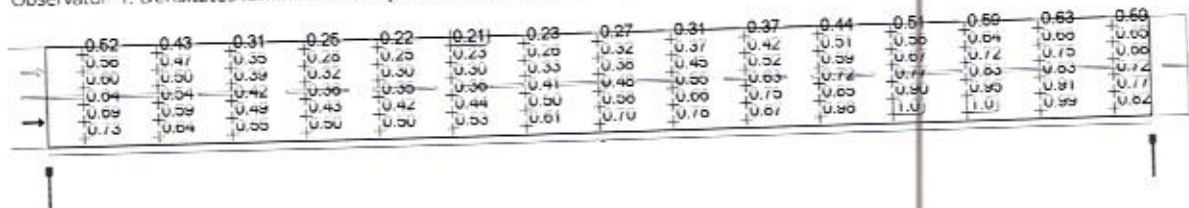

Observator 1: Densitatea luminii la instalația nouă [cd/m²] (Raster valoric)

m	1.467	4.400	7.333	10.267	13.200	16.133	19.067	22.000	24.933	27.867	30.800	33.733	36.667	39.600	42.533
3.667	0.52	0.43	0.31	0.25	0.22	0.21	0.23	0.27	0.31	0.37	0.44	0.51	0.59	0.63	0.59
3.000	0.56	0.47	0.35	0.28	0.25	0.23	0.26	0.32	0.37	0.42	0.51	0.58	0.64	0.68	0.65
2.333	0.60	0.50	0.39	0.32	0.30	0.30	0.33	0.38	0.45	0.52	0.59	0.67	0.72	0.75	0.68
1.667	0.64	0.54	0.42	0.36	0.35	0.36	0.41	0.48	0.55	0.63	0.72	0.77	0.83	0.83	0.72
1.000	0.69	0.59	0.49	0.43	0.42	0.44	0.50	0.58	0.66	0.75	0.85	0.90	0.95	0.91	0.77
0.333	0.73	0.64	0.55	0.50	0.50	0.53	0.61	0.70	0.78	0.87	0.98	1.04	1.05	0.99	0.82

Observator 1: Densitatea luminii la instalația nouă [cd/m²] (Tabel de valori)

	L _m	L _{min}	L _{max}	g ₁	g ₂
Observator 1: Densitatea luminii la instalația nouă	0.55 cd/m ²	0.21 cd/m ²	1.05 cd/m ²	0.377	0.200

PRESEDINTE DE SEDINTA
LAZA MATIUTA LIVIU

CONTRASEMNEAZA
SECRETAR GENERAL UAT VASCAU
POP RODICA

Stradă 1
Șosea 1 (M5)

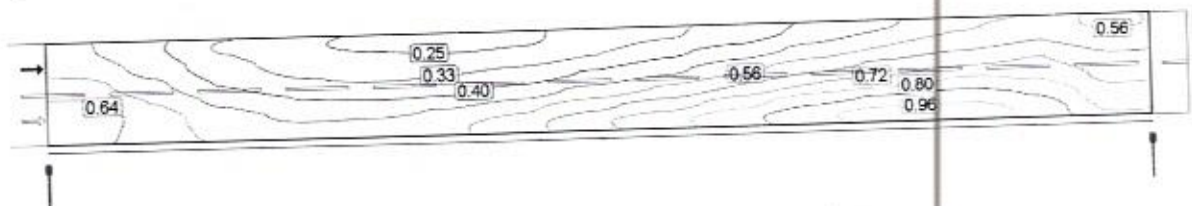

Observator 2: Valoarea de întreținere, densitatea luminii cu carosabil uscat (cd/m²) (Linii Isolux)

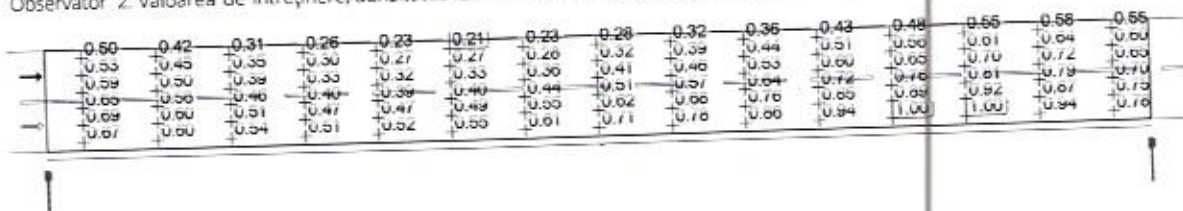

Observator 2: Valoarea de întreținere, densitatea luminii cu carosabil uscat (cd/m²) (Raster valoric)

m	1.467	4.400	7.333	10.267	13.200	16.133	19.067	22.000	24.933	27.867	30.800	33.733	36.667	39.600	42.533
3.667	0.50	0.42	0.31	0.26	0.23	0.21	0.23	0.28	0.32	0.36	0.43	0.48	0.55	0.58	0.55
3.000	0.53	0.45	0.35	0.30	0.27	0.27	0.28	0.32	0.39	0.44	0.51	0.56	0.61	0.64	0.60
2.333	0.59	0.50	0.39	0.33	0.32	0.33	0.36	0.41	0.46	0.53	0.60	0.65	0.70	0.72	0.65
1.667	0.65	0.56	0.46	0.40	0.39	0.40	0.44	0.51	0.57	0.64	0.72	0.76	0.81	0.79	0.70
1.000	0.69	0.60	0.51	0.47	0.47	0.49	0.55	0.62	0.68	0.76	0.85	0.89	0.92	0.87	0.75
0.333	0.67	0.60	0.54	0.51	0.52	0.55	0.61	0.71	0.78	0.86	0.94	1.00	1.00	0.94	0.78

Observator 2: Valoarea de întreținere, densitatea luminii cu carosabil uscat (cd/m²) (Tabel de valori)

	L _m	L _{min}	L _{max}	g ₁	g ₂
Observator 2: Valoarea de întreținere, densitatea luminii cu carosabil uscat	0.55 cd/m ²	0.21 cd/m ²	1.00 cd/m ²	0.373	0.206

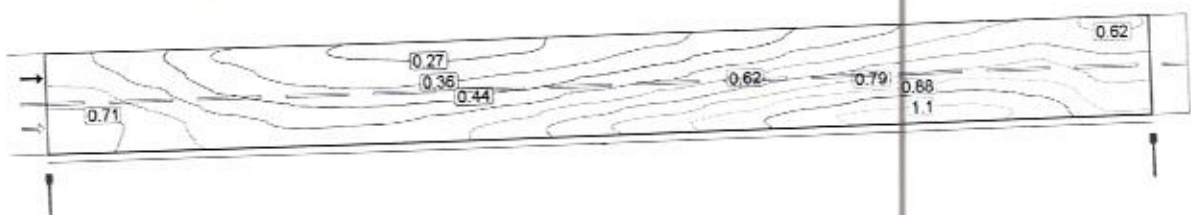

Observator 2: Densitatea luminii la instalația nouă (cd/m²) (Linii Isolux)

PRESEDINTE DE SEDINTA
LAZA MATIUTA LIVIU

CONTRASEMNEAZA
SECRETAR GENERAL UAT VASCAU
POP RODICA



Stradă 1

Șosea 1 (M5)

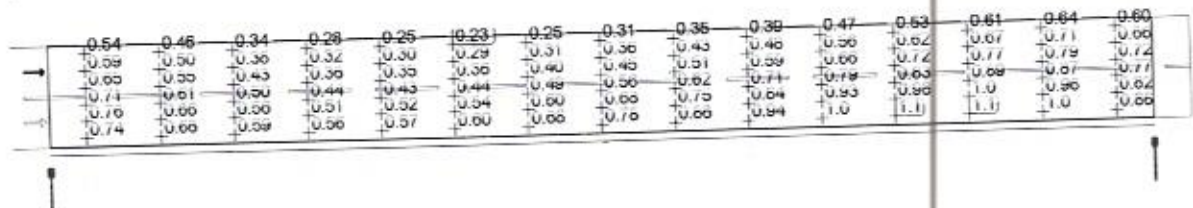

Observator 2: Densitatea luminii la instalația nouă [cd/m²] (Raster valoric)

m	1.467	4.400	7.333	10.267	13.200	16.133	19.067	22.000	24.933	27.867	30.800	33.733	36.667	39.600	42.533
3.667	0.54	0.46	0.34	0.28	0.25	0.23	0.25	0.31	0.35	0.39	0.47	0.53	0.61	0.64	0.60
3.000	0.59	0.50	0.38	0.32	0.30	0.29	0.31	0.36	0.43	0.48	0.56	0.62	0.67	0.71	0.66
2.333	0.65	0.55	0.43	0.36	0.35	0.36	0.40	0.45	0.51	0.59	0.66	0.72	0.77	0.79	0.72
1.667	0.71	0.61	0.50	0.44	0.43	0.44	0.49	0.56	0.62	0.71	0.79	0.83	0.89	0.87	0.77
1.000	0.76	0.66	0.56	0.51	0.52	0.54	0.60	0.68	0.75	0.84	0.93	0.98	1.01	0.96	0.82
0.333	0.74	0.66	0.59	0.56	0.57	0.60	0.68	0.78	0.86	0.94	1.04	1.10	1.10	1.03	0.86

Observator 2: Densitatea luminii la instalația nouă [cd/m²] (Tabel de valori)

	L_m	L_{min}	L_{max}	g_1	g_2
Observator 2: Densitatea luminii la instalația nouă	0.61 cd/m ²	0.23 cd/m ²	1.10 cd/m ²	0.373	0.206

PRESEDINTE DE SEDINTA
LAZA MATIUTA LIVIU

CONTRASEMNEAZA
SECRETAR GENERAL UAT VASCAU
POP RODICA

